

Specifications

Lattice Boom Crawler Crane

LS-218H II HYLAB Series

110-ton* (100 metric ton)

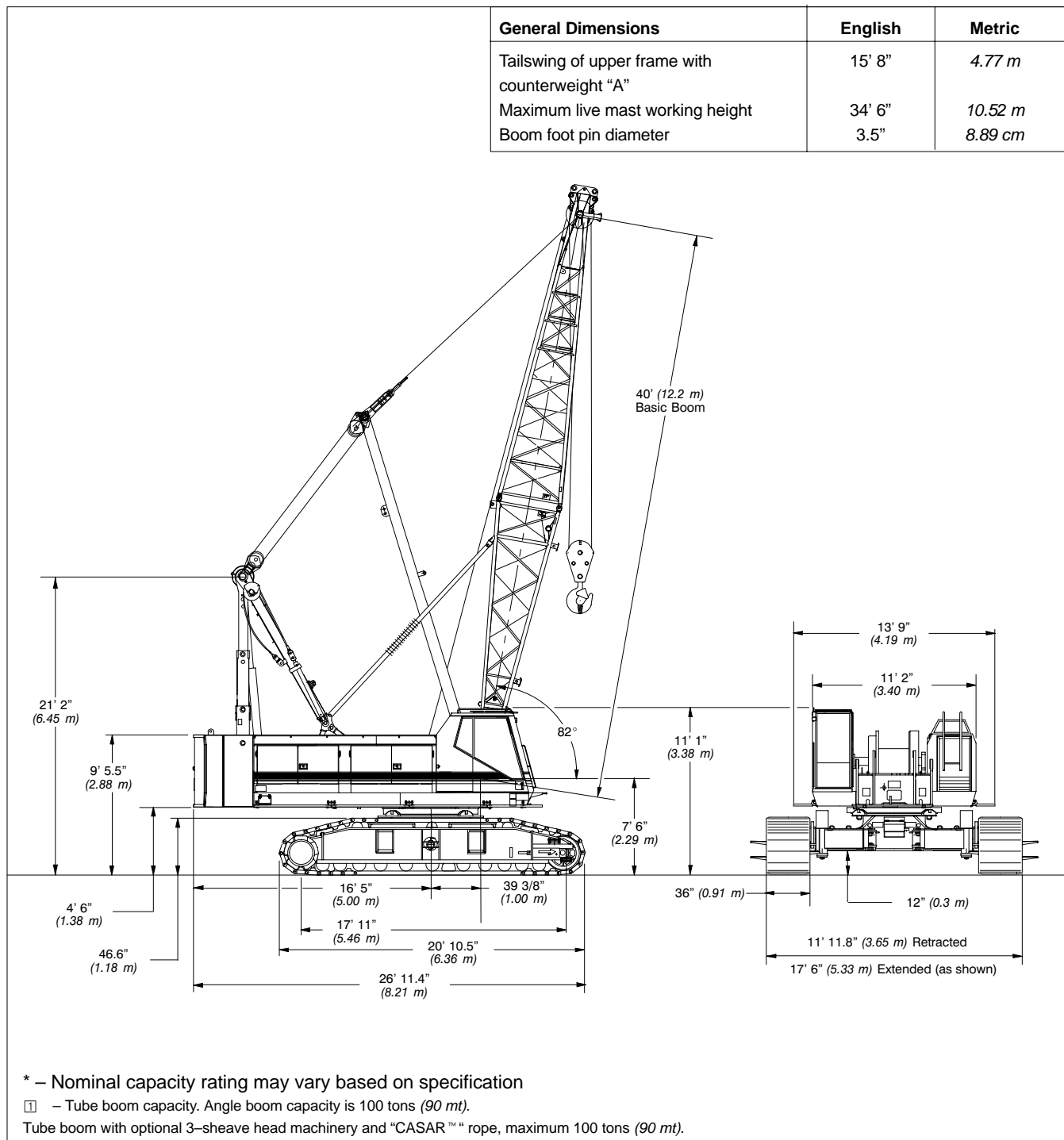

LS-218H II Machine Transport Weights – approximate

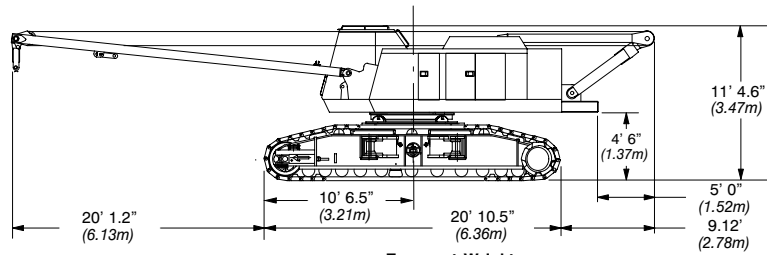
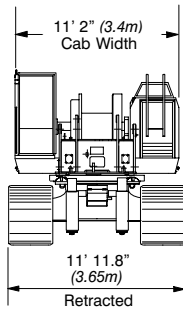

Transport Weight
Rope on both drums, Backstops, Catwalks and full tank of fuel
121,152 lbs. (54 954kg)

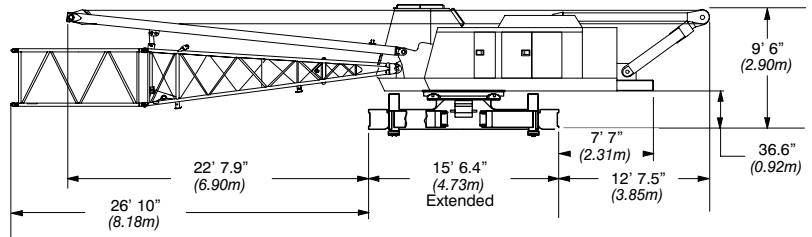
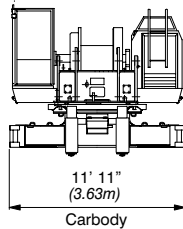

Upper & Carbody Shipping Weight
Rope on both drums, Backstops, Catwalks, and a full tank of fuel
76,865 lbs. (34 865kg)

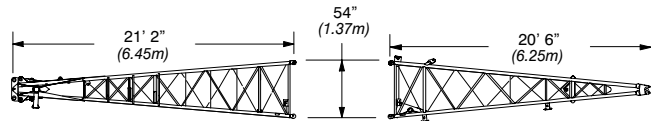
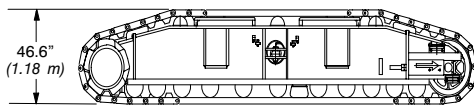

20' (6.1m) Top Section
Tube: 3,690 lbs. (1 674kg)
Angle: 3,646 lbs. (1 653kg)

20' (6.1m) Base Section
Tube: 1,991 lbs. (903kg)
Angle: 2,695 lbs. (1 222kg)

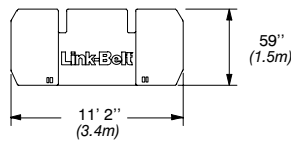
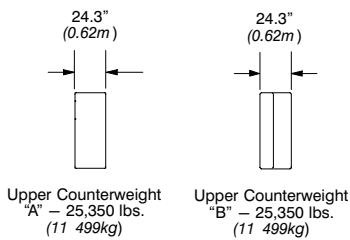
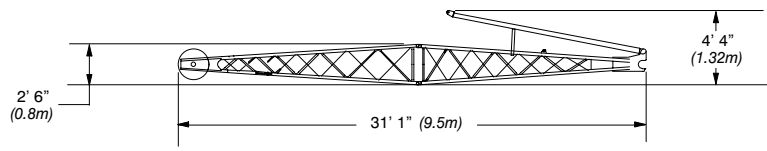
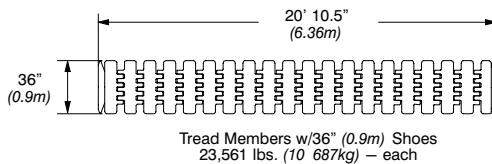

Third Drum without rope
1,850 lbs. (839kg)



Carbody Jack minimum and maximum heights

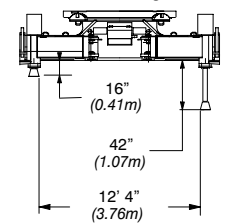

LS-218H II Transportation Weights – approximate

Base Machine: Rigid Boom Backstops, 77 Gallons (291L) of fuel, Catwalks (right and left side), Lower jacking system, 26' (7.9m) Live Mast, Bridle & Spreader Bar, 10-Part Boom Hoist Reeving, 700' (213.36m) of type 'DB' Front Hoist Rope, 650' (198.12m) of type 'RB' Rear Hoist Rope.

Item Description	Gross Weight		Transport Loads					Notes and Load Summary
	lb.	kg.	#1	#2	#3	#4	#5	
Base Machine (without base section)	74,030	33 579	1					<p>Numbers in the load columns to the left represent quantities.</p> <p>Estimated transport assumes the load out consist of 230' (70.1m) of tube boom + 75' (22.86m) of jib with full counterweight.</p> <p>Support loads were targeted at 45,000 lb (20 412kg), 8'-6" (2.6m) wide, 48' (14.6m) long, and 13'-6" (4.1m) high using a drop deck trailer. This may vary depending on state laws, empty truck/trailer weights, and style of trailer.</p> <p>Estimated weights vary by +/- 2%.</p> <p>Estimated Total Load of #1 77,488 lbs. (35 148kg).</p> <p>Estimated Total Load of #2 26,808 lbs. (12 160kg).</p> <p>Estimated Total Load of #3 26,808 lbs. (12 160kg).</p> <p>Estimated Total Load of #4 35,092 lbs. (15 918kg)</p> <p>Estimated Total Load of #5 30,542 lbs. (13 854kg)</p>
Add "A" Counterweight	25,350	11 499				1		
Add "B" Counterweight	25,350	11 499					1	
Add a Treadmember (2 required)	23,561	10 687		1	1			
Add Hydraulic Third Drum w/o rope	1,850	839						
Add 20' (6.1m) Tube Base Section	1,991	903	1					
Add 20' (6.1m) Tube Top Section	3,690	1 674				1		
Add 10' (3.05m) "HP" Tubular Extension w/pins & pendants	844	383	1					
Add 20' (6.1m) "HP" Tubular Extension w/pins & pendants	1,353	614		1	1			
Add 30' (9.1m) "HP" Tubular Extension w/pins & pendants	1,894	859		1	1			
Add 40' (12.2m) "HP" Tubular Extension w/pins & pendants	2,357	1 069				1	1	
Add 20' (6.1m) Angle Base Section	2,695	1 222						
Add 20' (6.1m) Angle Top Section with 4 Lifting Sheaves	3,646	1 654						
Add 20' (6.1m) Angle Top Section with 3 Lifting Sheaves	3,400	1 542						
Add 20' (6.1m) Angle Top Section with 2 Lifting Sheaves	3,300	1 497						
Add 10' (3.05m) Angle Extension w/pins & pendants	1,047	475						
Add 20' (6.1m) Angle Extension w/pins & pendants	1,696	769						
Add 30' (9.1m) Angle Extension w/pins & pendants	2,448	1 110						
Add Bridle & Spreader Bar Only (No Live Mast)	885	401						
Add Quick Draw Assembly	623	283	1					
Add Tagline Winder w/rope	1,040	472						
Add Fairleader	500	227						
Add PAT DS-350	100	45						
Add 30' (9.1m) Tubular Jib	1,965	891					1	
Add 15' (4.6m) Tubular Jib Extension	290	132					3	
Add 5' (1.5m) Auxiliary Tip Extension	640	290						
Add Pile Driver Lead Adapter	198	90						
Add Holding Rope – 1" X 190' Type 'DB'	352	160						
Add Closing Rope – 1" X 240' Type 'DB'	444	201						
Add Inhaul Rope – 1" X 105' Type 'M'	185	84						
Add Hoist Rope – 1" X 700' Type 'DB'	1 295	587						
Add Hoist Rope – 1" X 700' Type 'CC'	1,421	645						
Add jib Wire Rope – 1" X 700' Type 'DB'	1,295	587						
Add 3rd Drum Wire Rope 0.75" X 550' Type 'DB'	572	259						
Add Auxiliary Lifting Bail	196	89						
Add 15-ton (13.6mt) Hook Ball – Non Swivel	750	340				1		
Add 15-ton (13.6mt) Hook Ball – Swivel	760	345						
Add 110-ton (100mt) 4 Sheave Hook Block	2,946	1 336				1		
Remove Front Hoist Rope 1" X 700' Type 'DB'	-1,232	-559						
Remove Jib Wire Rope 1" X 650' Type 'RB'	-1,300	-590						
Remove 26' (7.9m) Live Mast with Bridle & Spreader Bar	-2,949	-1 338						
Remove 50 gallons (189.3L) of fuel	-362	-164						

LS-218H II Machine Working Weights

Option	Description	Gross Weight lbs. (kg)	Ground Bearing Pressure psi (kg/cm ²)
1	Base machine equipped with 40' (12.2m) of tube boom, live mast, "A" counterweight, 700' (213m) front hoist rope, 650' (198m) rear hoist rope, 110-ton (99.8mt) hook block, 77 gallons (291.4L) of fuel, and 200 lbs. (90.7kg) operator.	155,276 (70 432)	9.68 (0.68)
2	Option #1 plus "B" counterweight, midpoint pendants, and 190' (57.9m) of boom extensions to obtain 230' (70.1m) of main boom.	192,877 (87 488)	12.02 (0.85)
3	Option #2 plus 75' (22.86m) of jib and 15-ton (13.6mt) hook ball – subtract 40' (12.19m) of boom extension and midpoint pendants to obtain maximum 190' + 75' (57.9 + 22.9m) of main boom + jib.	193,906 (87 954)	12.08 (0.85)
4	Option #3 Base machine equipped with 40' (12.2m) of angle boom, live mast, "A" counterweight, 700' (213m) front hoist rope, 650' (198m) rear hoist rope, 110-ton (99.8mt) hook block, 77 gallons (291 L) of fuel, and 200 lbs. (90.7kg) operator.	155,936 (70 731)	9.72 (0.69)
5	Option #4 plus "B" counterweight and 110' (33.5m) of boom extensions to obtain 150' (45.7m) of main boom.	190,621 (86 464)	11.88 (0.84)
6	Option #5 plus 60' (18.3m) of jib and 15-ton (13.6mt) hook ball to obtain maximum 150' + 60' (45.7 + 18.3m) of main boom + jib.	193,916 (87 959)	12.03 (0.85)

Notes:

- Ground bearing pressure is based on the total weight distributed evenly over the track contact area.
- Total contact area for 36" (0.91m) track shoes is 16,047 in² (103 529cm²).

LS-218H II Luffing Attachment Dimensions

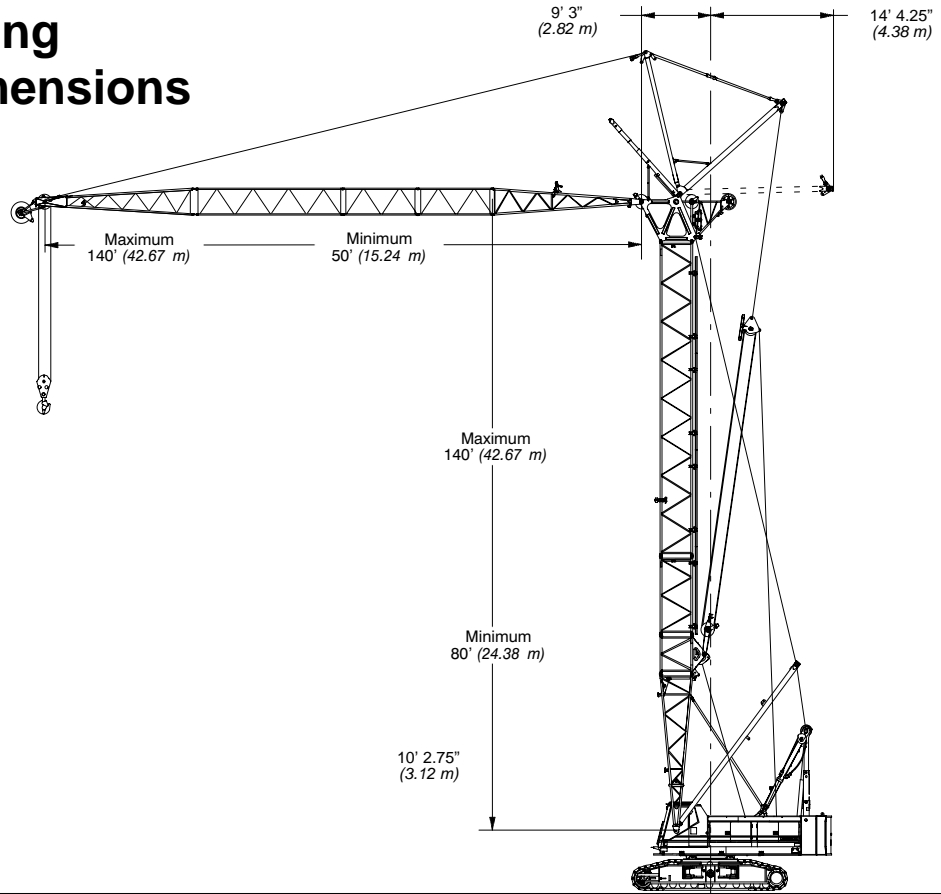

LS-218H II Luffing Attachment Transport

Luffing Shipping Module #1: 7,214 lbs. (3 272 kg)

Luffing jib base section, luffing boom top section and the front and rear fan post.

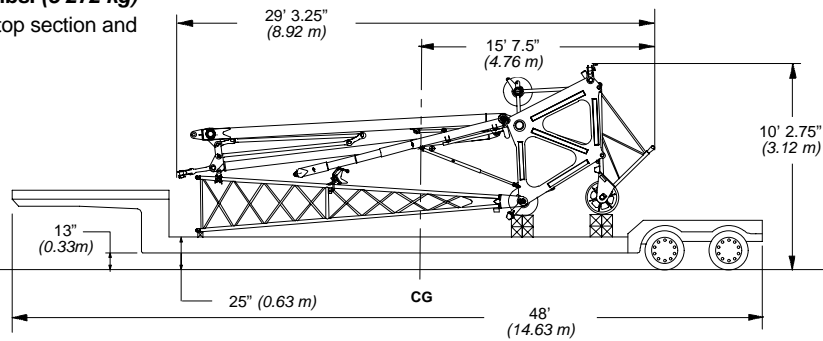

Luffing Shipping Module #2: 6,699 lbs. (3 039 kg)

Luffing jib peak assembly with nose wheel, 30' section (two each), 20' section (one each), 10' section (two each), 25-ton hookblock and 15-ton hookball.

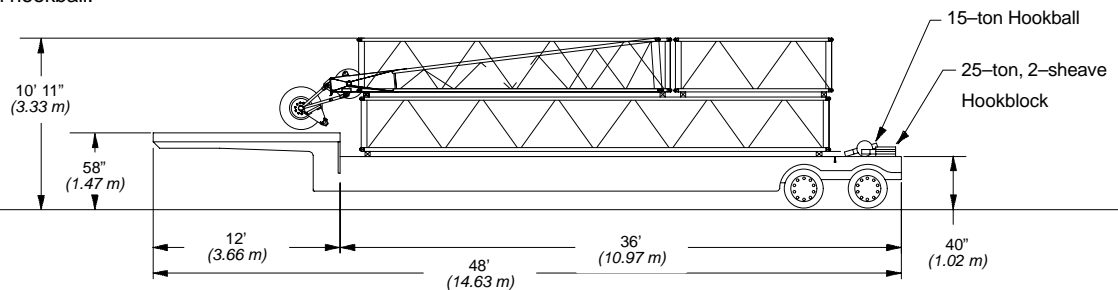

LS-218H II Luffing Attachment Nomenclature

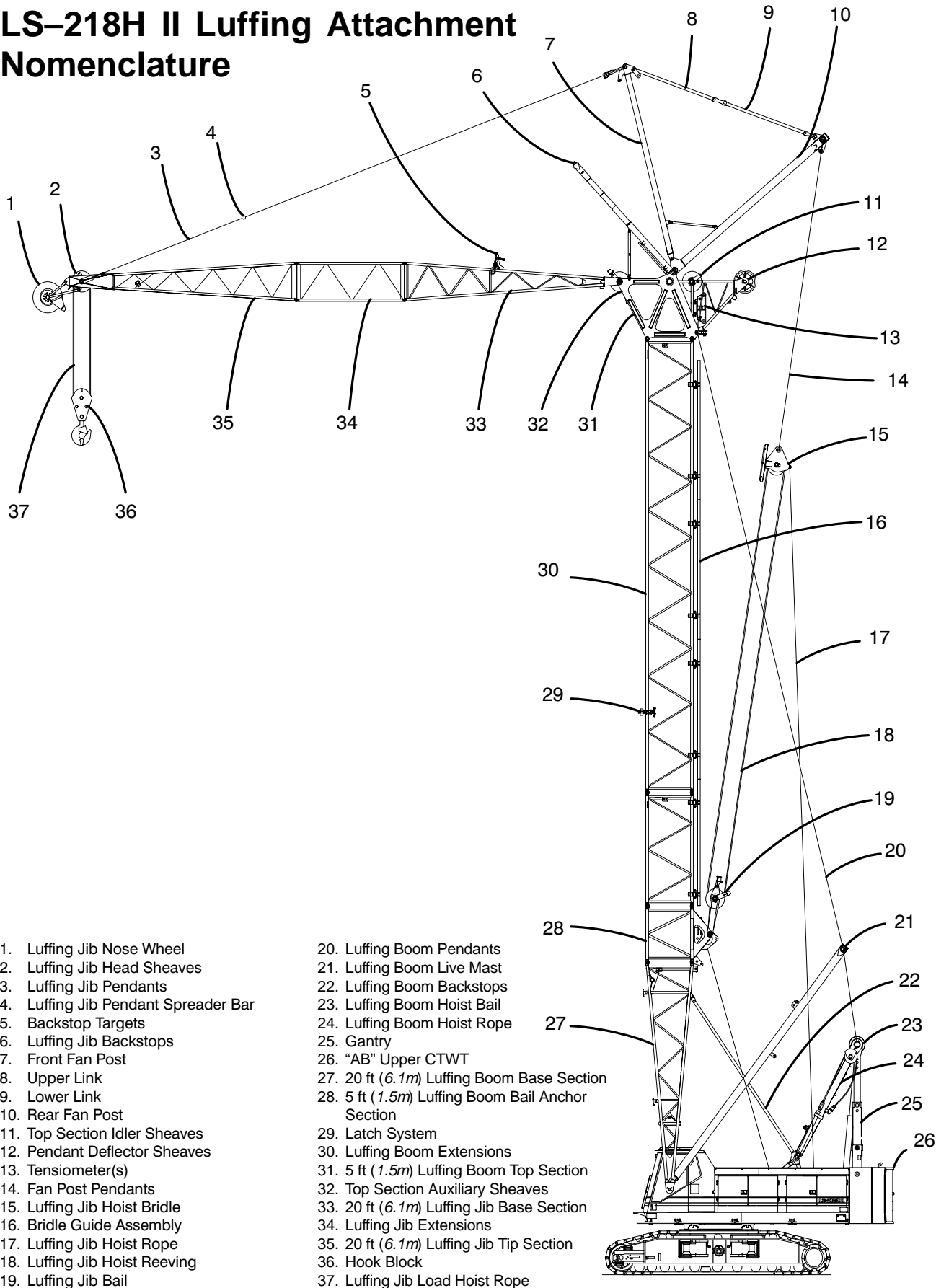

- 1. Luffing Jib Nose Wheel
- 2. Luffing Jib Head Sheaves
- 3. Luffing Jib Pendants
- 4. Luffing Jib Pendant Spreader Bar
- 5. Backstop Targets
- 6. Luffing Jib Backstops
- 7. Front Fan Post
- 8. Upper Link
- 9. Lower Link
- 10. Rear Fan Post
- 11. Top Section Idler Sheaves
- 12. Pendant Deflector Sheaves
- 13. Tensiometer(s)
- 14. Fan Post Pendants
- 15. Luffing Jib Hoist Bridle
- 16. Bridle Guide Assembly
- 17. Luffing Jib Hoist Rope
- 18. Luffing Jib Hoist Reeving
- 19. Luffing Jib Bail

- 20. Luffing Boom Pendants
- 21. Luffing Boom Live Mast
- 22. Luffing Boom Backstops
- 23. Luffing Boom Hoist Bail
- 24. Luffing Boom Hoist Rope
- 25. Gantry
- 26. "AB" Upper CTWT
- 27. 20 ft (6.1m) Luffing Boom Base Section
- 28. 5 ft (1.5m) Luffing Boom Bail Anchor Section
- 29. Latch System
- 30. Luffing Boom Extensions
- 31. 5 ft (1.5m) Luffing Boom Top Section
- 32. Top Section Auxiliary Sheaves
- 33. 20 ft (6.1m) Luffing Jib Base Section
- 34. Luffing Jib Extensions
- 35. 20 ft (6.1m) Luffing Jib Tip Section
- 36. Hook Block
- 37. Luffing Jib Load Hoist Rope

Attachment Options

■ 40' – 230' Tubular Boom (12.19 – 70.1 m)

Basic Boom – 40' (12.19 m) two-piece design that utilizes a 20' (6.10 m) base section and a 20' (6.10 m) open throat top section with in-line connecting pins on 60" (1.52 m) wide and 50" (1.27 m) deep centers.

- Boom feet on 61" (1.55 m) centers
- 3" (76.2 mm) diameter chords
- Lugs on base section to attach carrying links
- Skywalk platform
- Deflector roller on top section
- Permanent skid pads mounted on top section to protect head machinery
- Four 21" (0.53 m) root diameter steel sheaves mounted on sealed anti-friction bearings
- Tip extension and jib connecting lugs on top section
- Mechanical boom angle indicator

Optional – "Quick Draw™" handling system that mounts in the boom base to allow loading/unloading of a counterweight, a tread member or a boom section onto transport trailers.

Tube Boom Extensions – The following table provides the lengths available and the suggested quantity to obtain maximum boom in 10' (3.05 m) increments. Midpoint pendant connections are required at 100' (30.5 m) for boom lengths 210' (64.0 m) and longer.

Tube Boom Extensions	Suggested Quantity for Max. Boom
10' (3.05 m)	1
20' (6.10 m)	2
30' (9.14 m)	2
40' (12.19 m)	2

- Deflector roller on top of each section
- Appropriate length pendants
- Maximum tube boom tip height of 235' (71.63 m)

■ 40'–150' Angle Boom (12.19 – 45.72 m)

Basic Angle Boom – 40' (12.2 m) two-piece design that utilizes a 20' (6.10 m) base section and a 20' (6.10 m) open throat top section with in-line connecting pins. Boom extensions are 48" (1.22 m) wide and 48" (1.22 m) deep at outside dimensions of angles.

- Boom feet on 61" (1.55 m) centers
- 4" X 4" X 0.38" (101.6 x 101.6 x 9.5 mm) angle chords

- Lugs on base section to attach carrying links
- Skywalk platform
- Deflector roller on top section
- Rigid sheave guards
- Four 18" (0.5 m) root diameter steel sheaves mounted on sealed anti-friction bearings
- Tip extension and jib connecting lugs on top section
- Mechanical boom angle indicator

Optional – Three sheave head machinery for clam applications or two wide mouth sheaves for dragline applications.

- Three sheave lift crane head machinery instead of standard (when used with "CASAR™ Stratoplast" rope) offers maximum capacity of 100 tons (90 mt).

Angle Boom Extensions – The following table provides the lengths available and the suggested quantity to obtain maximum boom in 10' (3.05 m) increments. Midpoint pendant connections are not required.

Angle Boom Extensions	Suggested Quantity for Max. Boom
10' (3.05m)	1
20' (6.10m)	2
30' (9.14m)	2

- Deflector roller on top of each section
- Appropriate length pendants
- Maximum angle boom tip height of 156' (47.56 m)

■ 30' – 75' Tubular Jib (9.14–22.86m)

Basic Tube Jib – 30' (9.14 m) two-piece design that utilizes a 15' (4.57 m) base section and a 15' (4.57 m) top section with in-line connecting pins on 32" (0.81 m) wide and 24" (0.61 m) deep centers.

- 2" (50.8 mm) diameter tubular chords
- One 18.5" (0.46 m) root diameter steel sheave mounted on sealed anti-friction bearings.
- 15' (4.6 m) jib extensions provide jib lengths at 45' (13.76 m), 60' (18.3 m) and 75' (22.86 m) for tube boom. Angle boom is limited to 60' (18.29 m).
- Jib offset angles at 5, 15 and 25 degrees
- Maximum tip height of tube boom + jib is 269.5' (82.14 m).
- Maximum tip height angle boom + jib is 215' (65.57 m).

■ Auxiliary 5' Tip Extension (1.5m)

Designed to use in place of jib to provide clearance between working hoist lines. The extension is equipped with two nylon 18" (0.46 m) root diameter sheaves mounted on sealed anti-friction bearings. Maximum capacity is 9-ton (8.16 mt).

■ 50' – 140' (15.24 – 42.67 m) Luffing Jib

Basic Luffing Jib – 50' (15.24 m) four-piece design utilizes a 20' (6.10 m) base section, 10' (3.05 m) extension, 20' (6.10 m) top section with in-line connecting pins and 5' (1.5 m) luffing boom top section. Boom extensions are 39" (0.99 m) wide and 48" (1.22 m) deep at the centers.

- 25-ton (22.68 mt) maximum capacity
- Working lengths of 50' (15.24 m) to 140' (42.67 m)
- Brackets on base section to attach fan-post transport links
- Two steel 22.5" (0.57 m) diameter luffing jib head sheaves
- Two polyamide 21.25" (0.54 m) diameter luffing boom auxiliary head sheaves
- Pin-on nose wheel
- Eight-part luffing jib hoist.
- 1.25" (31.75 mm) diameter type "N" pendants
- Anemometer with in-cab display

Luffing Jib Extensions – The following table provides the lengths available and the suggested quantity to obtain the maximum luffing jib in 10' (3.05 m) increments. Midpoint pendants are not required.

Luffing Jib Extensions	Suggested Quantity for Max. Boom
10' (3.05 m)	1
20' (6.10 m)	1
30' (9.14 m)	2

- Deflector roller on top of each extension
- Appropriate length pendants
- Max. luffing jib tip height of 283' (86.26 m)

■ Luffing Boom

- Common base and extensions as open throat boom (HP boom only)
- 5' (1.5 m) luffing extension required for bail anchor
- Working angles of 90, 85, 80, 75, 70, and 65 degrees.
- Working lengths of 80' (24.38 m) to 140' (42.67 m) with luffing jib combinations up to 140' (42.67 m)
- Maximum luffing boom length 150' (45.72 m) with luffing jib combinations of 80' (24.38 m), 90' (27.43 m), and 100' (30.48 m) only.
- 1.38" (34.92 mm) diameter type "N" pendants; same as open throat boom.

Luffing Boom Extensions – The following table provides the lengths available and the suggested quantity to obtain the maximum luffing boom in 10' (3.05 m) increments. Midpoint pendants are not required.

Luffing Boom Extensions	Suggested Quantity for Max. Boom
10' (3.05 m)	1
20' (6.10 m)	2
30' (9.14 m)	1
40' (12.19 m)	1

- Note: "HP" type boom must be used.
- Rear hoist drum becomes luffing jib hoist
 - Optional third drum provides second working hoist line, if required.
 - Designed for self-assembly

- Luffing jib hoist bridle and bail can remain reeved for machine transport
- Job site mobility with attachment
- Rolled out or rolled under erection methods
- Compact transport module.

■ Boom Hoist System

Designed to lift off maximum boom or maximum boom plus jib unassisted. Operates up to a maximum boom angle of 82 degrees. Boom hoist limit system limits maximum boom angle operation.

- Retractable gantry frame and
- Pin-on bail frame
- 10-part reeving with 3/4" (19 mm) wire rope

- Bridle assembly
 - 26' (7.92 m) live mast (optional for angle attachment)
 - Two 1.38" (35 mm) pendants
 - Tubular boom backstops (telescopic type)
 - Sheaves contain sealed anti-friction bearings
 - Boom speed from 10°–70° is 69 seconds with no load. Speed was determined using 100' (30.5 m) of tube boom.
- Note – DS-350 required when using luffing attachment.

Revolving Upper Structure

■ Frame

All welded steel frame with precision machined surfaces for mating parts.

■ Engine

Mitsubishi 6D24-TEB with oil filter, oil cooler, air cleaner, fuel filter, water separator, tachometer and electrical shutdown.	
Number of cylinders	6
Bore and stroke – in. (mm)	5.12 x 5.91 (130 x 150)
Piston displacement – in ³ (cm ³)	729 (11 945)
Engine rpm at full load speed	2,000
Hi-idle rpm	2,325
Full load speed – hp. (kw)	263 (196)
Peak torque – ft. lb. (joule)	746 (1011)
Peak torque – rpm	1,400
Electrical system	24 volt
Batteries	2–12 volt
Approximate fuel consumption	Gal./hr (L/hr)
100% H.P.	13.84 (52.40)
75% H.P.	10.38 (39.29)
50% H.P.	6.92 (26.19)
25% H.P.	3.46 (13.10)

- One fixed displacement gear type pump operating at 1,200 psi (84.4kg/cm²) and 10.5 gal/min (39.7L/min) powers the pilot control system, clutches, brakes and pump controls.

Pump Control ("Fine Inching") mode – Special pump setting, selectable from operator's cab, that allows very slow movements of load hoist drums, boom hoist drum, and travel for precision work.

Hydraulic Reservoir – 79 gal (300L), equipped with sight level gauge. Diffusers built in for deaeration.

Filtration – One 10 micron, full flow, line filter in the control circuit. All oil is filtered prior to entering the reservoir.

Counterbalance Valves – All hoist motors are equipped with counterbalance valves to provide positive load lowering and prevent accidental load drop if the hydraulic pressure is suddenly lost.

■ Load Hoist Drums

Each drum contains a pilot controlled, bi-directional, axial piston motor and a planetary gear reduction unit to provide positive control under all load conditions.

- Power up/down & free-fall operation modes
- Automatic brake mode (spring applied, hydraulically released, band type brake)
- 1" (25.4mm) grooved lagging
- Drum pawl controlled manually
- Electronic drum rotation indicators
- Mounted on anti-friction bearings
- 21.50" (0.54m) root diameter
- 40.94" (1.04m) flange diameter
- 24.63" (0.62m) width

Note: The freefall operational mode is designed to prevent load lowering even if the freefall switch is accidentally activated.

The automatic brake mode meets all OSHA requirements for personnel handling.

Drum Clutches – Speed-o-Matic™ power hydraulic two shoe clutch design that uses a 37" (940 mm) diameter x 5" (127 mm) wide shoe that internally expands to provide load control. Swept area is 638 in² (4 116 cm²).

■ Optional Front Mounted Third Hoist Drum

The hydraulic winch is pinned to the front of the upper frame and is used in conjunction with a fleeting sheave and 3-sheave idler assembly to run the wire rope over the boom top section.

- Free-spooling capability for pile driving applications or auxiliary hoist line for luffer applications.
- 12.75" (0.32m) root diameter
- 22.75" (0.58m) flange diameter
- 17" (0.43m) width
- Mounted on anti-friction bearings

■ Boom Hoist Drum

Contains a pilot controlled, bi-directional, axial piston motor and a planetary gear reduction unit to provide positive control under all load conditions.

- Spring applied, hydraulically released, disc type brake controlled automatically
- 3/4" (19mm) grooved lagging
- Drum pawl controlled automatically
- Mounted on anti-friction bearings
- 19.84" (0.50m) root diameter
- 33.86" (0.86m) flange diameter
- 9.82" (0.25m) width

■ Hydraulic System Specifications

Hydraulic Pumps – The pump arrangement is designed to provide hydraulically powered functions allowing positive, precise control with independent or simultaneous operation of all crane functions.

- Two variable displacement pumps operating at 4,000 psi (281kg/cm²) and 83 gal/min (315L/min) powers load hoist drums, boom hoist drum, optional third drum, and travel.
- Fixed displacement gear type pump operating at 3,600 psi (250kg/cm²) and 31 gal/min (117L/min) powers the motors, treadmember retract cylinders or jacking cylinders.
- One fixed displacement gear type pump operating at 3,000 psi (210kg/cm²) and 35 gal/min (130L/min) powers the swing motors.

■ Swing System

Pilot controlled bi-directional axial piston motors and the planetary gear reduction unit to provide positive control under all load conditions.

- Spring applied, hydraulically released, 360 degree multi-plate brake
- Free swing mode when lever is in neutral position
- Four position positive house lock
- Two-speed swing
- Audio/Visual swing alarm
- Maximum swing speed is 2.4 rpm

■ Upper Counterweight

Consist of a two piece design that can be easily lowered to the ground using the gantry.

- 25,350 lbs. (11 499kg) "A" upper counterweight
- Optional – 25,350 lbs. (11 499kg) "B" upper counterweight can be added to maximize capacities

■ Operator's Cab and Controls

Fully enclosed modular steel compartment is independently mounted and insulated to protect against vibration and noise.

- All tinted/tempered safety glass
- Sliding entry door and front window
- Swing up roof window with wiper
- Door and window locks
- Heater with circulating fan
- Air Conditioner
- Sun visor

- Engine instrumentation panel (tachometer, voltmeter, engine oil pressure, engine water temperature, fuel level, hydraulic oil temperature, hour meter and service monitor system)
 - Electronic drum rotation indicators for front and rear hoist drums
 - Six way adjustable seat
 - Dry chemical fire extinguisher
 - Hand and foot throttle
 - Fully adjustable single axis arm chair controls
 - Swing lever with swing brake and horn located on handle
 - Bubble type level
 - Ergonomic gauge layout
 - Control shut off lever
- (continued on page 7)*

■ Load Indicator / Rated Capacity Limiter

Standard Equipment – PAT EI-65 load indicator provides two linersiders, angle sensor, computer, display, and anti-two block equipment to provide the following information.

- Boom length & angle
- Jib length & angle
- Load on hook
- Load radius
- Tip height
- Anti-two block warning & function limiters
- Operation mode
- Operator settable alarms provide audio/visual warning

Optional Equipment – PAT DS-350 rated capacity limiter, with graphic display, provides all the same equipment and features of the standard EI-65 in conjunction with the following features.

- Provides an audio/visual warning when the load on hook is within 90% of the cranes rated load.
- Provides an audio/visual warning and limits functions when the load on hook is at 100% of the cranes rated load.

Note: The DS-350 function limiters are activated for anti-two block and overload conditions. These limiters are designed to prevent hoist up on front and rear drums and boom down.

■ Additional Equipment – Standard

- 71.02" (1.80m) outside diameter turntable bearing
- Right and Left side removable catwalks
- 119 US Gallon (450.4L) fuel tank (usable quantity)
- Machine lifting links

■ Additional Equipment – Optional

- Rud-o-matic® model 648 tagline winder
- Full revolving type Fairleader with barrel, sheaves, and guide rollers.

Optional Equipment – PAT DS-350 rated capacity limiter, with graphic display, provides all the same equipment and features of the standard EI-65 in conjunction with the following features.

- Provides an audio/visual warning when the load on hook is within 90% of the cranes rated load.
- Provides an audio/visual warning and limits functions when the load on hook is at 100% of the cranes rated load.

Note: The DS-350 function limiters are activated for anti-two block and overload conditions. These limiters are designed to prevent hoist up on front and rear drums and boom down.

LS-218H II Load Hoisting Performance

Available line speed and line pull – based on Mitsubishi 6D24-TEB at 2,000 rpm full load speed. Line pulls are not based on wire rope strength. See Wire Rope Capacity Chart for maximum permissible single part of line working loads.

Rope Layer	Front or Rear Drum – 1" (25.4 mm) Wire Rope											
	Maximum Line Pull		No Load Line Speed		Full Load Line Speed		Pitch Diameter		Layer		Total	
	lb	kg	ft/min	m/min	ft/min	m/min	in	mm	ft	m	ft	m
1	55,844	25 331	200	61.0	69	21.1	22.5	571	132	40.1	132	40.1
2	51,284	23 262	218	66.4	75	23.0	24.5	622	143	43.7	275	83.8
3	47,413	21 507	236	71.9	82	24.9	26.5	673	155	47.2	430	131.0
4	44,086	19 997	254	77.3	88	26.7	28.5	724	167	50.8	596	181.9
5	41,194	18 686	271	82.7	94	28.6	30.5	775	178	54.4	775	236.2
6	38,659	17 536	289	88.1	100	30.5	32.5	825	190	57.9	965	294.2
7	Storage layer only						34.5	876	202	61.5	1,167	355.7

Rope Layer	Boom Hoist Drum – 3/4" (19mm) Wire Rope											
	Maximum Line Pull		No Load Line Speed		Full Load Line Speed		Pitch Diameter		Layer		Total	
	lb	kg	ft/min	m/min	ft/min	m/min	in	mm	ft	m	ft	m
1	38,722	17 564	128	38.9	58	17.7	20.6	523	64	19.5	64	19.5
2	36,093	16 371	137	41.7	62	18.9	22.1	561	69	21.0	133	40.5
3	33,798	15 331	146	44.5	66	20.2	23.6	599	73	22.4	206	62.9
4	31,777	14 414	155	47.4	71	21.5	25.1	637	78	23.8	284	86.7
5	29,985	13 601	165	50.2	75	22.8	26.6	675	83	25.2	367	111.9
6	28,384	12 875	174	53.0	79	24.1	28.1	714	87	26.6	454	138.5
7	26,945	12 222	183	55.9	83	25.4	29.6	752	92	28.1	546	166.6
8	25,645	11 633	193	58.7	87	26.7	31.1	790	97	29.5	643	196.1

Rope Layer	Front Mounted Third Drum – 3/4" (19mm) Wire Rope											
	Maximum Line Pull		No Load Line Speed		Full Load Line Speed		Pitch Diameter		Layer		Total	
	lb	kg	ft/min	m/min	ft/min	m/min	in	mm	ft	m	ft	m
1	23,000	10 433	160	48.8	102	31.1	13.5	343	80	24.4	80	24.4
2	20,700	9 389	178	54.2	114	34.7	15	381	89	27.1	169	51.5
3	18,820	8 537	196	59.7	125	38.1	16.5	419	98	29.9	267	81.4
4	17,250	7 824	214	65.2	137	41.7	18	457	107	32.6	374	114.0
5	15,925	7 223	232	70.7	148	45.1	19.5	495	116	35.4	490	149.4
6	14,785	6 706	249	75.9	160	48.8	21	533	124	37.8	614	187.1

Wire Rope Application	Diameter		Length		Type	Maximum Permissible Load	
	in	mm	ft	m		lbs	kg
Boom Hoist	3/4	19	550	167	AC	20,857	9 461
Front Hoist	1	25.4	700	213	DB	29,500	13 380
Front Hoist (Optional)	1	25.4	700	213	CC	30,760	13 952
Rear Hoist (Optional)	1	25.4	650	198	RB	22,760	10 324
Third Drum (Optional)	3/4	19	385	117	DB	16,800	7 620

Rope Type	Description
DB	6 x 26 (6 X 19 Class) – Warrington Seale – Extra Improved Plow Steel – Preformed – Right Lay – Regular Lay – I.W.R.C.
RB*	19 x 19 Rotation Resistant – Extra Improved Plow Steel – Preformed – Right Lay – Regular Lay – Swaged – SF=5.1
CC	36 x 7 – Non-rotating – Extra-Extra Improved Plow Steel – Right Lay – Regular Lay – S.F.=5.1
AC	9 x 40 Strand, Post Formed, Swaged – Constructex – Crush Resistant

* – Use of swivel ball is not recommended.

Lower Structure

■ Lower Frame

All welded box construction frame with precision-machined surfaces for turntable bearing and rotating joint.

- 10'-8" (3.25m) overall width
- 11'-11" (3.6m) overall length

■ Treadmembers

All welded, precision-machined, steel frames can be hydraulically extended and retracted by a hydraulic cylinder mounted in the lower frame.

- 14'-6" (4.42m) extended gauge
- 9' (2.74m) retracted gauge
- 20'-11" (6.37m) overall length
- 36" (0.9m) wide track shoes
- 11 sealed (oil filled) track rollers per treadmember
- Sealed (oil filled) idler and drive planetaries
- Compact travel drives
- Hydraulic adjusting tracks

Travel and Steering – Each treadmember contains a pilot controlled, bi-directional, axial piston motor and a planetary gear reduction unit to provide positive control under all load conditions.

- Individual control provides smooth, precise maneuverability including full counter-rotation.
- Spring applied, hydraulically released disc type brake controlled automatically.
- Maximum travel speed is 0.90 mph (1.45km/h).
- Designed to 30% gradeability.

■ Carbody Jacks

System contains four hydraulic cylinders individually mounted on swing out beams.

- Individual controls are mounted on carbody.
- Minimum height of carbody when resting on pontoons is 16" (0.41m).
- Maximum height of carbody when resting on pontoons is 42" (1.07m).

This Page Intentionally Blank

