

# Specifications

Hydraulic Lattice Boom Crawler Crane

## LS-248H II

200-Ton (181.50 metric ton)

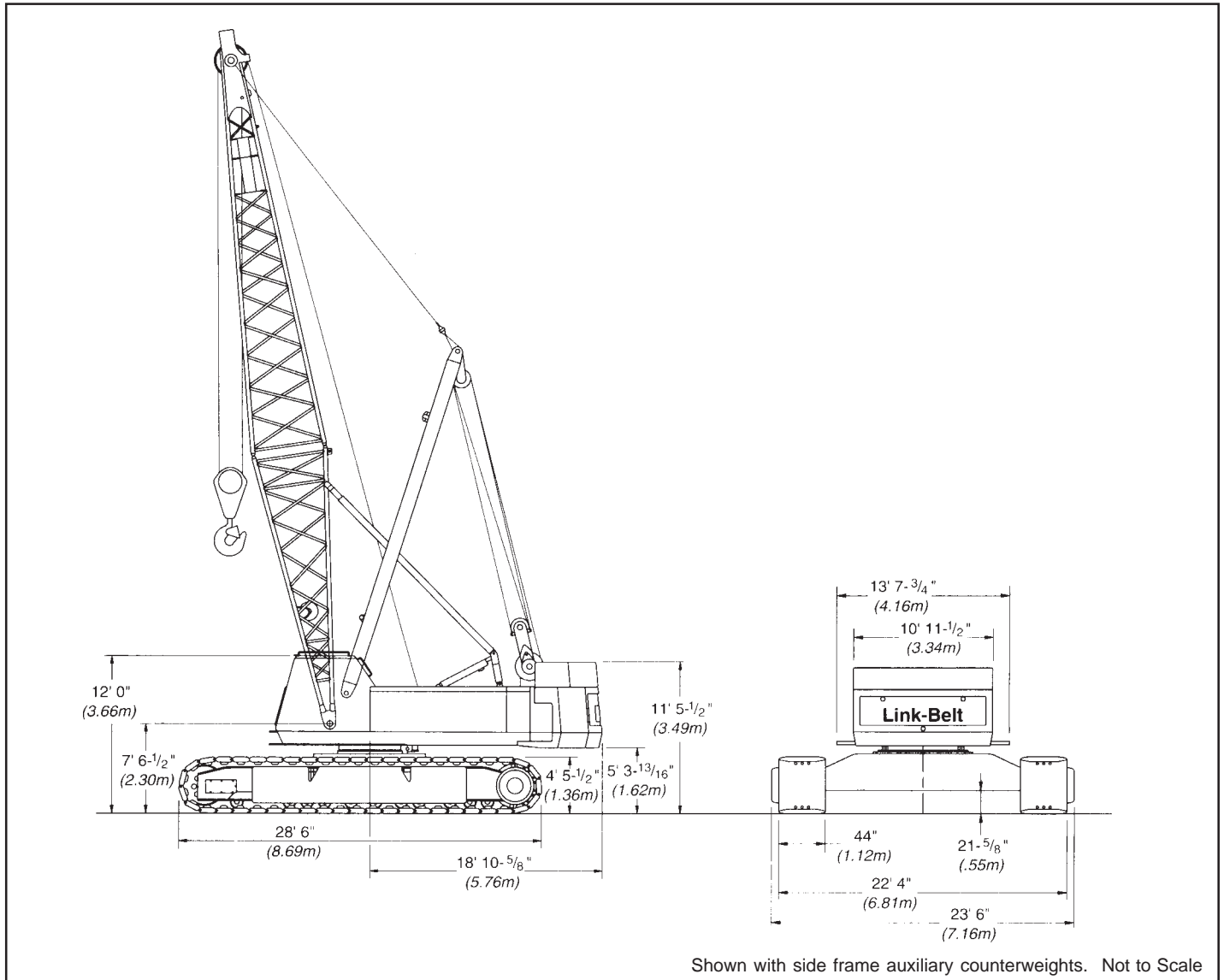

Shown with side frame auxiliary counterweights. Not to Scale

General dimensions	feet	meters
Basic boom length	50	15.24
Overall width of machine with 44" (1.12 m) track shoes	22.5	6.85
Overall width of cab w/catwalks both sides	13.64	4.15
Overall width of cab less catwalks	10.95	3.34

General dimensions	feet	meters
Tailswing of counterweight "A"	16.80	5.12
Tailswing of counterweight "AB"	18.89	5.76
Tailswing of counterweight "ABC"	18.89	5.76
Overall height for transport w/boom base	13.31	4.05
Overall height for transport w/live mast only	13.31	4.05

# Machine Working Weights - approximate

Based on standard machine with Isuzu A-6SD1TQB-01 diesel engine, turntable bearing, independent hydraulic powered drums, boomhoist limiting device, independent hydraulic swing and travel, swing brake, drum rotation indicators, and 18' 10" (5.74 m) gauge by 28' 6" (8.69 m) long crawler lower with 44" (1.12 m) wide track shoes, track rollers with dirt seals, 48,000 lb. (21 772 kg) side frame auxiliary counterweights, catwalks, hydraulic boomfoot pin removal, plus the following:	<b>Equipped with upper ctwt. "A" + side frame ctwts.</b>		<b>Equipped with upper ctwt. "AB" + side frame ctwts.</b>		<b>Equipped with upper ctwt. "ABC" + side frame ctwts.</b>	
	lbs.	kg	lbs.	kg	lbs.	kg
Lifting Crane - includes 50' (15.24 m) basic tubular boom, 30' (9.14 m) live mast, 1,050' (320.04 m) of 1" (25 mm) diameter wire rope, 715' (217.93 m) of 7/8" (22 mm) diameter boomhoist rope, 175-ton (159 mt) hookblock, and basic pendants.	224,560	101 860	269,300	122 154	298,260	135 290

# Transport Weights and Dimensions - ±3%

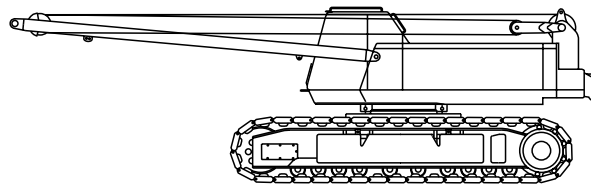

**Assembly Weight**  
166,700 lbs. (75 615 kg)

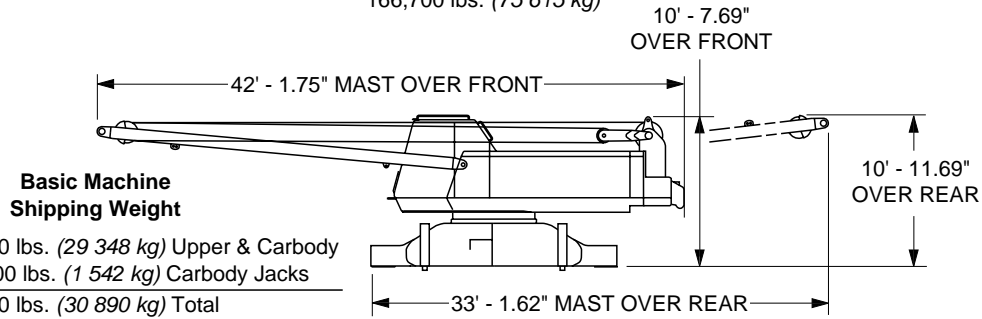
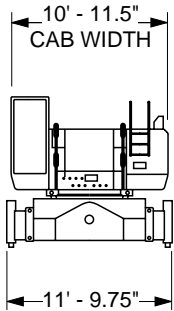

**Basic Machine Shipping Weight**  
64,700 lbs. (29 348 kg) Upper & Carbody  
+ 3,400 lbs. (1 542 kg) Carbody Jacks  
68,100 lbs. (30 890 kg) Total

**"C" Upper Counterweight**  
28,960 lbs. (13 136 kg)

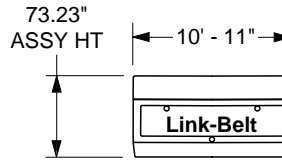
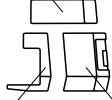

**"ABC" Counterweight Assembly**

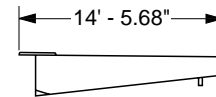

**Counterweight Assist Frame**  
4,900 lbs. (2 223 kg)  
(not included in basic machine weight)

**"A" Upper Counterweight**  
22,730 lbs. (10 310 kg)

**"B" Upper Counterweight**  
44,740 lbs. (20 294 kg)

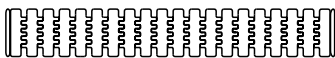
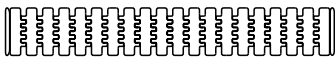

**Tread Members**  
36,600 lbs. (16 602 kg) each

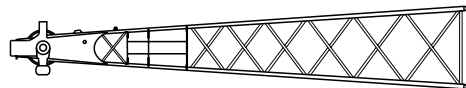

**30' (9.14 m) Peak Section**  
4,130 lbs. (1 873 kg)

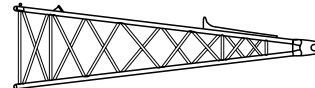

**20' (6.10 m) Base Section**  
4,650 lbs. (2 109 kg) - w/o third drum winch assembly  
9,830 lbs. (4 459 kg) - w/third drum winch assembly

68" x 80" cross-section tubular boom

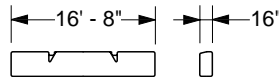

**Side Frame Auxiliary Counterweights (2)**  
24,000 lbs. (10 886 kg) each  
(not included in basic machine weight)

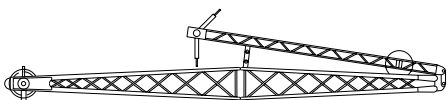

**30' (9.14 m) Jib Assembly**  
1,900 lbs. (862 kg)

Optional Boom Sections	
10' (3.05 m) boom extension	840 lbs. (381 kg)
20' (6.10 m) boom extension	1,680 lbs. (762 kg)
30' (9.14 m) boom extension	2,520 lbs. (1 143 kg)
40' (12.19 m) boom extension	3,360 lbs. (1 524 kg)

## Crawler Mounting

### Lower frame

All welded high strength steel (100,000 psi yield), box construction; precision machined surfaces for turntable bearing and axle plates.

### Turntable bearing

Outer race bolted to lower frame; inner race with internal swing gear bolted to upper.

### Crawler side frames

All welded, precision machined and removable. Each side frame comes with lifting brackets. Positioned on cross axles by dowels and held in place with adjustable wedgepacks.

### Crawler side frame auxiliary counterweights

Removable 24,000 lb. (10 886 kg) auxiliary counterweight on each crawler side frame.

### Track drive sprockets

Cast steel, heat treated; self-cleaning and sealed for lifetime lubrication. Powered by hydraulic motor(s) through double reduction gear drive.

### Track carrier slide rails

Slide rails on top of each side frame.

### Track rollers

Heat treated, oil filled, mounted on "sealed for life" anti-friction bearings; 12 per side crawler side frame.

### Tracks

Heat treated, self-cleaning, multiple hinged track shoes joined by one piece full floating pins; 51 shoes per side frame - 44" (1.12 m) wide.

**Track tension adjustment** - Idler wheel adjusted by means of hydraulic cylinder and hand pump. Idler wheel shaft held in position with shims after adjustment is made.

### Take up idlers

Cast steel, heat treated, self-cleaning, mounted on aluminum/bronze bushings. Lubricated through idler shaft.

### Independent hydraulic travel/steering

Power transmitted by axial piston hydraulic motors through planetary gear reduction unit to track drive sprocket.

**Steering** - Axial piston motor with reduction gear is located at inner drive end of each crawler side frame. Each track is driven simultaneously or individually for straight-line, gradual turn, or pivot turn. The tracks can be counterrotated for spin turns.

**Brakes** - Spring applied, hydraulically released multiple disc brakes are applied automatically when the control lever is in the neutral position.

Travel speed - 0 - .50 mph (0 - 0.80 km/hr).

Gradeability - 30%

### Jacking system

*Optional*; four ground controlled, power hydraulic jacks, pinned to the lower carbody frame, used to raise the machine to facilitate removal or installation of the crawler side frames.

### Ground contact area and ground bearing pressure

Based on standard machine equipped with "ABC" counterweight and 50' (15.24 m) tubular boom.

Track shoes		Ground contact area		Ground bearing pressure	
inches	meters	sq. in.	cm <sup>2</sup>	psi	kg/cm <sup>2</sup>
44	1.12	12,760	82 328	11.6	0.82

## Revolving Upperstructure

### Frame

All welded and precision machined.

### Turntable bearing

With integral swing (ring) gear. Inner race with internal swing gear is bolted to upper revolving frame; outer race is bolted to machined surface on lower.

### Engine

Full pressure lubrication, oil filter, air cleaner, hour meter and throttle, electric control shutdown.

### Fuel tank

77 gallon (291 liter) capacity; equipped with fuel sight level gauge, flame arrester, and self-closing cap with locking eye for padlock.

Engine Specifications	Isuzu A-6SD1TQB-01
Number of cylinders	6
Bore and stroke: inch - (mm)	4.72 x 5.71 (120 x 145)
Piston displacement - cu. in. - (cm <sup>3</sup> )	600 (9 839)
High idle speed - rpm	2,400
Engine rpm at full load speed	2,200
Net engine hp at full load speed	237
Peak torque - foot pounds - joules	644 (873.3)
Peak torque - rpm	1,500
Electrical system	24-volt
Batteries	2 - 12 volt

# LS-248H II Load Hoisting Performance

Available line speed and line pull

Line pulls are not based on wire rope strength. See wire rope chart below for maximum permissible single part of line working loads.

## Line Speeds and Pulls

Rope layer	Front Drum - 1" (25 mm) wire rope						Rear Drum - 1" (25 mm) wire rope					
	Maximum line pull		No load line speed		Full load line speed		Maximum line pull		No load line speed		Full load line speed	
	lbs.	kg	ft./min	m/min	ft./min	m/min	lbs.	kg	ft./min	m/min	ft./min	m/min
1	48,620	22 055	225	68.5	112	34.2	29,360	13 318	372	113.4	186	56.7
2	44,200	20 050	247	75.3	124	37.7	26,690	12 108	409	124.8	205	62.4
3	40,510	18 379	270	82.2	135	41.1	24,470	11 099	446	136.1	223	68.0
4	37,400	16 965	292	89.0	146	44.5	22,590	10 245	484	147.5	242	73.7
5	34,720	15 753	315	95.9	157	47.9	20,970	9 513	521	158.8	260	79.4
6	32,410	14 703	337	102.7	168	51.3	19,570	8 877	558	170.1	279	85.1
7	30,390	13 784	359	109.6	179	54.7	18,350	8 324	595	181.5	298	90.7

Rope layer	Boomhoist Drum - 7/8" (22 mm) wire rope						Third Drum - 1" (25 mm) wire rope					
	Maximum line pull		No load line speed		Full load line speed		Maximum line pull		No load line speed		Full load line speed	
	lbs.	kg	ft./min	m/min	ft./min	m/min	lbs.	kg	ft./min	m/min	ft./min	m/min
1	40,842	18 526	147	44.9	134	40.8	20,656	9 369	442	135	105	32
2	36,760	16 674	163	49.8	149	45.3	18,752	8 506	486	148	116	35
3	33,417	15 158	180	54.8	163	49.8	17,169	7 788	531	162	127	39
4	30,633	13 895	196	59.8	178	54.4	15,833	7 182	576	176	138	42
5	28,276	12 826	213	64.8	193	58.9	14,690	6 663	621	189	148	45
6	26,257	11 910	229	69.7	208	63.4	--	--	--	--	--	--
7	24,506	11 116	245	74.7	223	67.9	--	--	--	--	--	--

## Wire Rope Drum Capacities

Rope layer	Boomhoist Drum Capacity - 7/8" (22 mm) rope					
	Pitch Diameter		Layer		Total	
	in.	mm	ft.	m	ft.	m
1	15.88	403.2	51.8	15.8	51.8	15.8
2	17.63	447.7	57.1	17.4	108.9	33.2
3	19.38	492.1	62.3	19.0	171.2	52.2
4	21.13	536.6	67.2	20.5	238.5	72.7
5	22.88	581.0	72.5	22.1	311.0	94.8
6	24.63	625.5	77.4	23.6	388.4	118.4
7	26.38	669.9	82.7	25.2	471.1	143.6

Rope layer	Front Drum Capacity - 1" (25 mm) wire rope					
	Pitch Diameter		Layer		Total	
	in.	mm	ft.	m	ft.	m
1	20	508	113	34.3	113	34.3
2	22	559	123	37.4	235	71.7
3	24	610	133	40.4	368	112.1
4	26	660	142	43.4	510	155.5
5	28	711	153	46.5	663	202.0
6	30	762	163	49.6	825	251.6
7	32	813	173	52.6	998	304.2

Rope layer	Rear Drum Capacity - 1" (25 mm) wire rope					
	Pitch Diameter		Layer		Total	
	in.	mm	ft.	m	ft.	m
1	20	508	113	34.3	113	34.3
2	22	559	123	37.4	235	71.7
3	24	610	133	40.4	368	112.1
4	26	660	142	43.4	510	155.5
5	28	711	153	46.5	663	202.0
6	30	762	163	49.6	825	251.6
7	32	813	173	52.6	998	304.2

Rope layer	Third Drum Capacity - 1" (25 mm) wire rope					
	Pitch Diameter		Layer		Total	
	in.	mm	ft.	m	ft.	m
1	19.7	500	150	45.8	150	45.8
2	21.7	551	165	50.4	316	96.2
3	23.7	602	181	55.1	496	151.3
4	25.7	653	196	59.7	692	211.0
5	27.7	704	211	64.4	903	275.3
6	29.7	754	226	68.9	1,129	344.1

## Wire Rope: size, type and working strength

Wire rope application	Size: diameter		Type	Max. permissible load	
	inches	mm		lbs.	kg
Boomhoist	7/8	22	LB	25,000	11 340
Main load hoist	1	25	N	29,500	13 400
Jib load hoist (1-part)	1	25	RB	22,760	10 320
Jib load hoist (2-parts)	1	25	RB	45,520	20 640
Boom pendants (dual)	1	25	N	69,000	31 300
Jib staylines	7/8	22	N	26,550	12 040

## Wire Rope: types available

- Type "N" - 6 x 25 (6 x 19 class) filler wire, extra improved plow steel, preformed, independent wire rope center, right lay, regular lay.
- Type "LB" - 6 x 25 (6 x 19 class) filler wire, preformed, independent wire rope center, right lay, regular lay.
- Type "RB" - 19 x 19 non-rotating, extra, extra improved plow steel, preformed, right regular lay, swaged.

## Hydraulic System

### Hydraulic pumps

Two variable displacement piston pumps operating at 4,000 psi (281.24 kg/cm<sup>2</sup>) power travel, main drum, auxiliary drum, third drum, and boomhoist functions. Two fixed displacement gear pumps operating at 3,000 psi (211 kg/cm<sup>2</sup>) power swing, counterweight lowering, and machine jack functions. One fixed displacement gear pump operating at 1,210 psi (85 kg/cm<sup>2</sup>) powers pilot control system, clutches, brakes, and pump controls.

### "Fine Inching" pump control mode

Special fine metering pump setting selectable from the operator's cab allows very slow movements for precision work. Main hoist, auxiliary hoist, boomhoist, third drum, and travel are all supplied with this standard feature.

### Hydraulic reservoir

42 gal. (159 L), equipped with sight level gauge.

### Relief valves

Each function is equipped with relief valves to protect the circuit from overload or shock.

### Brake valves

Travel circuit is provided with brake valves for all terrain capability.

### Hydraulic filtration

Ten micron, full flow line filter furnished in control circuit. All oil is filtered prior to return to sump tank.

### Hydraulic motors

Main hoist drum, auxiliary hoist drum, boomhoist, swing, and travel are powered by axial piston motors.

### Counterbalance valves

**Upper** - Hoist motors are equipped with counterbalance valves to provide positive load lowering and prevent accidental load drop when hydraulic power is suddenly reduced.

**Lower** - Travel motors equipped with counterbalance valve to prevent over-speeding of motors when traveling down an incline.

## Principal Operating Functions

### Control system

Remote controlled hydraulic servo for main drum and auxiliary drum. Mechanical linkage controls swing. Function speed is proportional to lever movement. Levers are adjustable for operator comfort.

### Load hoisting and lowering

Main and auxiliary hoist drums are driven by individual axial piston motors and reduction gearing. Load hoisting or lowering is provided by actuating or reversing a hydraulic motor. The control lever provides two speeds for hoisting and lowering. Hoisting or lowering speeds are proportional to lever movement.

**Freefall** - The incorporation of power hydraulic controlled, two-shoe clutches allow freefall operation of the main and auxiliary hoist drums for high cycle crane and duty cycle application. Mode selection switch on control panel allows operator to select the most productive operation mode.

### Load hoist drums

Main (front) and auxiliary (rear) hoist drums are 19" (.48 m) root diameter grooved for 1" (25 mm) wire rope. Mounted on anti-friction bearings.

**Third operating drum** - *Optional*; 12-1/2" (.32 m) grooved drum lagging, mounted in boom base section.

### Drum clutches

Speed-o-Matic® power hydraulic two-shoe clutches; internal expanding, lined shoes. Clutch spiders are splined to shafts; clutch drums are integral with hoist drums.

**Load hoist clutches** - Front and rear main drums - clutch drums 30" (.76 m) diameter, 6-1/2" (.17 m) width.

### Drum brakes

External contracting band type; operated by foot pedal equipped with a locking latch. Operator may select automatic brake mode\* (spring applied, hydraulically released), which will apply brakes when the hoist control lever is in the neutral position.

\*When in the automatic brake mode, the LS-248H II meets all OSHA requirements for personnel handling.

### Drum rotation indicators

Standard for front and rear drums. Audible-type indicators.

### Drum locking pawl

Standard for front and rear drums; electrically actuated and prevents drum rotation in a lowering direction.

### Anti two-block system

Standard - A switch mounted on the boom peak activates a buzzer to warn the operator of a two-block condition and simultaneously disengages hoist function while applying the hoist brakes.

### Swing system

Independent, hydraulic swing is driven by two axial piston motors through a gear reduction system; free swing when lever is in neutral position.

**Swing brake** - Spring applied, hydraulically released; controlled by button on swing control lever.

**Swing lock** - Mechanically controlled, two-position locking mechanism.

*Optional* - 360° locking mechanism available to meet New York City code.

**Swing speed** - Variable from 0 to 2 rpm.

### Boomhoist/lowering system

Independent, hydraulic boomhoist is driven by an axial piston motor through a gear reduction system. Boom hoisting or lowering is performed by actuating or reversing the motor. Boomhoist speed is infinitely variable. Boomhoist speed from 0° to 70° boom angle is 90 seconds.

### Boomhoist drum

Single grooved lagging 15" (.38 m) root diameter.

### Boomhoist drum locking pawl

Electrically operated.

### Boomhoist brake

Spring applied, hydraulically released, multiple disc type brake. Brake is automatically applied when control lever is in neutral position.



**Boomhoist limiting device** - Restricts hoisting boom beyond recommended minimum radius.

### ■ Electrical system

24 volt negative ground system with two 12-volt batteries. Standard lighting system includes: two 70 watt headlights mounted on machine front and one interior cab light.

### ■ Operator's cab

Full vision, modular compartment with safety glass panels. The completely independent cab is insulated against noise and vibration. Sliding operator's door, swing up roof window. Standard equipment includes: heater, air conditioner, defroster, windshield wiper, dry chemical fire extinguisher, sun visor, bubble-type level, fuel gauge, tachometer, hydraulic temperature gauge, engine oil pressure gauge, coolant temperature gauge, and service monitor system.

### ■ Machinery cab

Hinged doors (one on right side, two on left side) for machinery access. Equipped with rooftop access ladder, electric warning horn and skid resistant finish on roof.

### ■ Catwalks

Standard on right and left sides. Catwalks remove for reduced travel width.

### ■ Bail

Pinned to revolving frame. Seven sheaves are provided for 16 part boomhoist wire rope reeving. Sheaves mounted on "lifetime sealed" anti-friction bearings.

### ■ Counterweights

"A" upper ctwt. - 22,730 lb. (10 310 kg)

"AB" upper ctwt. - 67,470 lb. (30 604 kg)

"ABC" upper ctwt. - 96,430 lb. (43 741 kg)

Side frame ctwts. - see side frame auxiliary ctwt. description under Crawler Mounting on page 3.

## Boom and Jib

### ■ Tubular boom

Two-piece basic boom 50' (15.24 m) long with open throat top section. Boom 80" (2.03 m) wide, 68" (1.73 m) deep at connections. Alloy steel round tubular cords 4" (.10 m) outside diameter. Maximum boom length is 280' (85.34 m).

### ■ Base section

20' (6.10 m) long; boomfeet on 55" (1.40 m) centers.

### ■ Boom extensions

Available in 10', 20', 30' and 40' (3.05, 6.10, 9.14 and 12.19 m) lengths with appropriate length pendants.

### ■ Boom connections

In-line pin connections.

### ■ Boom top section

Open throat; 30' (9.14 m) long.

### ■ Boompoint machinery

Six 21" (.53 m) root diameter sheaves mounted on "lifetime sealed" anti-friction bearings.

### ■ Hydraulic boomfoot pin removal

Standard; Speed-o-Matic controlled; located between mounting lugs on boom base section.

### ■ Boom live mast

30' (9.14 m) long; supports boomhoist bridle and boom pendants. Required for all boom lengths. May be used as short boom for assembling and disassembly of side frames and boom, but is not intended for general crane service. Refer to operator's manual for boom live mast lifting capacities.

### ■ Jib

Tubular; two-piece basic jib 30' (9.14 m) long; 32" (.81 m) wide, 24" (.61 m) deep at centerline of connections. Alloy steel tubular chords 2-1/4" (57 mm) outside diameter.

**Base section** - 13' 3" (4.04 m) long.

**Jib extensions** - Available in 10' (3.05 m) and 20' (6.10 m) lengths with appropriate length pendants.

**Jib connections** - In-line, tapered pins.

**Tip section** - 15' (4.57 m) long; equipped with single peak sheave 21" (.53 m) root diameter, heat treated and mounted on anti-friction bearings. Anchor provided at peak of jib tip section for two-part load hoist wire rope (whipline) connection.

**Maximum jib length permitted** - 100' (30.48 m). All jib lengths may be mounted at 5°, 15°, or 25° offset to boom.

### ■ Jib mast

17' 10" (5.44 m) long, mounted on jib base section. Two deflector sheaves mounted within mast to guide whipline; mounted on anti-friction bearings. Two equalizer sheaves mounted on top of mast - one for jib frontstay line, one for jib backstay line.

**Jib staylines** - Front and back staylines. Back staylines vary in length depending on degree of jib offset from boom centerline; back staylines attached at bottom end of boom top section.

**Jib stops** - Telescoping type; pinned from jib mast to boom top section and from jib mast to jib base section.

## Auxiliary Equipment

### ■ Boom angle indicator

Pendulum type; mounted on boom base section. Electronic type readout on load indicator.

### ■ Hook blocks

Blocks, or weighted ball with swivel hook, *optional* - refer to price list.

### ■ Rated capacity limiter

Standard; PAT DS-350 rated capacity limiter, programmed with multiple charts, provides the operator with: main boom length, main boom angle, jib angle, jib length, operating mode, load radius, boom tip height, anti-two block indicator, pre-warning light, audible alarm, overload light, and load on hook.

### ■ Swing alarm

Standard; audio/visual warning device signals when upper is swinging.

### ■ Lifting slings

For handling side frames and auxiliary side frame counterweights.

**This page intentionally blank**

